

enkelwerkende anti rotatie klemcilinders

TECHNISCHE GEGEVENS	
Medium	on- of gesmeerde perslucht
Aansluiting	G1/8
Werkdruk	2 tot 10 bar
Omgevingstemperatuur	-20° C tot +80° C
Cilinderbuis	Geanodiseerd aluminium
Zuigerstang	Roestvast staal
Afdichting	NBR

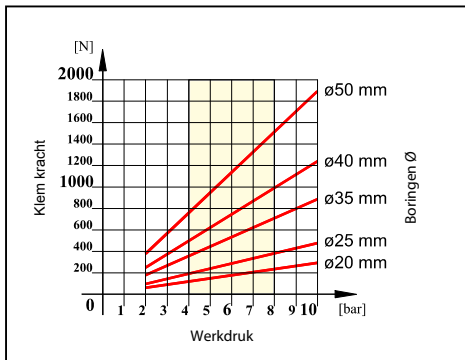

Bestelcode:

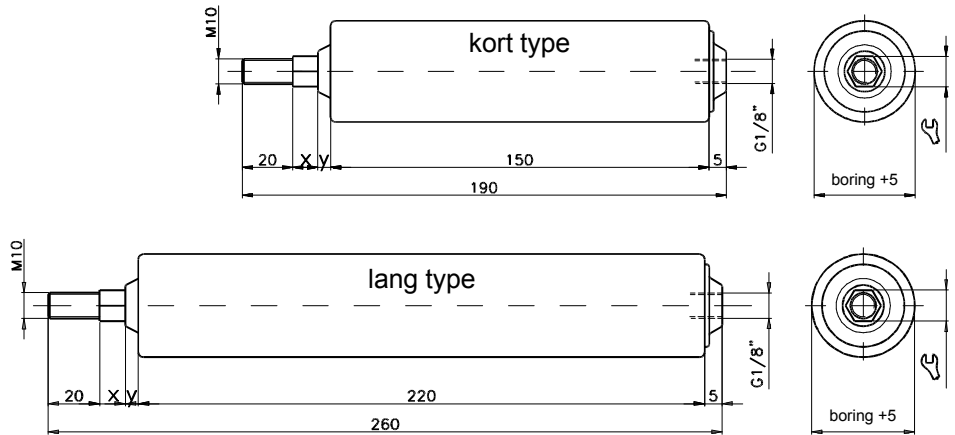
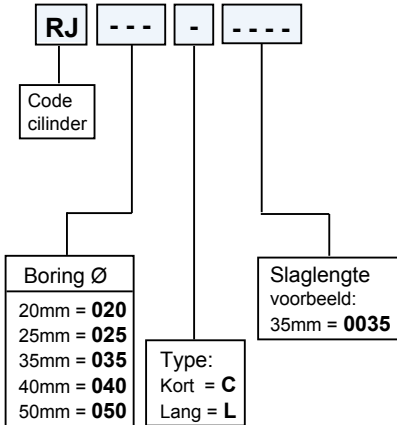

Boring	Ø20	Ø25	Ø35	Ø40	Ø50
	12	12	18	18	18
X	10	10	5	5	5
Y	5	5	12	12	12

C = Standaard slaglengte (mm)

Type	8	10	15	20	30	45	50	55	75	115
Kort	●	●	●	●	●	●	●	●	●	N.L.
Lang	●	●	●	●	●	●	●	●	●	●

Dop voor op de zuigerstang

Bestelnr.: **BUS00002**

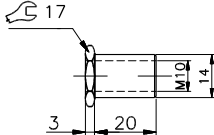

Stootdop voor op de zuigerstang

bestelnr.: voor Ø 35 **TPN00001**
 voor Ø 40 **TPN00002**

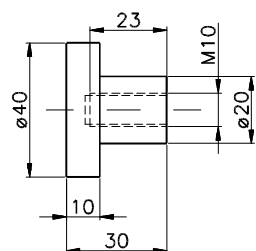
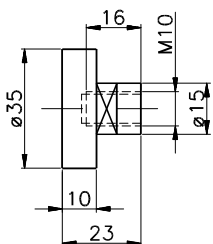

OPTIE

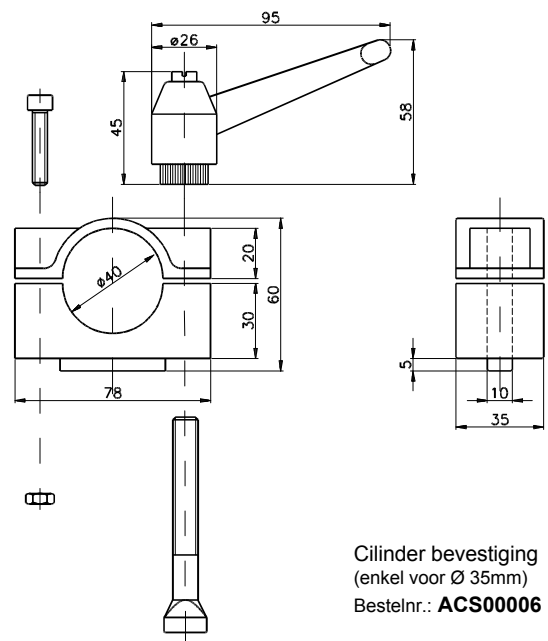

Cilinder bevestiging
 (enkel voor Ø 35mm)
 Bestelnr.: **ACS00006**